

Article number: 20036442

Description: E+G Ball knob DIN 319-KT-32-M8-C

## Measures

---

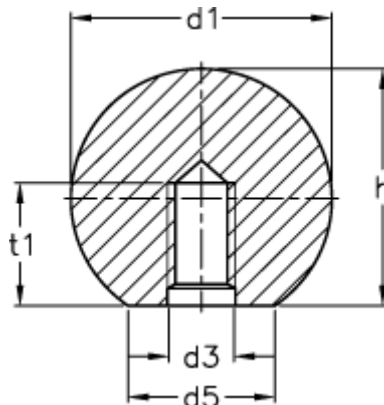

d1	= 32
d3	= M8
d5	= 18
h	= 29.0
t1 min.	= 14.5